

Tragfähigkeit

500 kg

Flanschbreite

121 mm - 220 mm

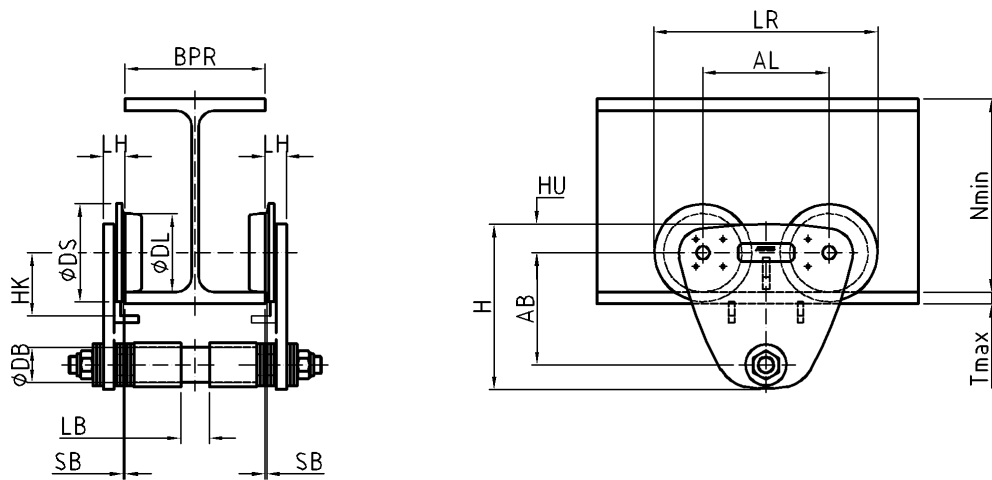

Maße und Gewichte

AL	120 mm	AB	100 mm	DS	85 mm		
DL	65 mm	DB	30 mm	HU	32 mm		
H	153 mm	HK	55 mm	LR	205 mm	N _{min}	120 mm
LB	24 mm	LH	19 mm				
SB _{max}	2 mm	T _{max}	20 mm				

Gewicht Fahrwerk 6,7 kg

BPR _{min}	BPR _{max}	Kurvenradius
121 mm	180 mm	>= 1300 mm
181 mm	220 mm	>= 1600 mm

ABUS Kransysteme GmbH
 Sonnenweg 1
 51647 Gummersbach

Fahrwerk HF06

30.10.2012